



WEB BASED APPLICATION SPECIFIC INSTALLATION INSTRUCTIONS



Foam Sealing Tapes

Although all possible measures have been taken to insure the accuracy of the material presented, WIXSYS, and the author are not liable and do not assume any liability in case of misinterpretation of directions, misapplication, improper installation, or typographical error.

Recommended Application of Slow-expansion Weather-resistant Foam Tape for Windows and Doors

Step 1:

Seal the sill area of the block opening to prepare for adhesive-backed flashing

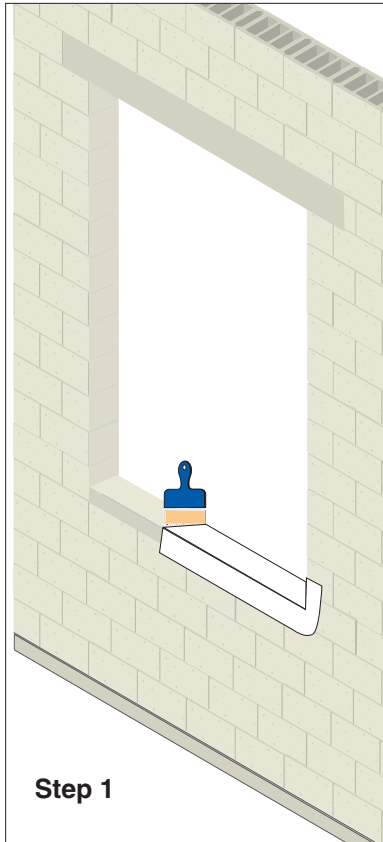

Step 1

Step 3:

Cut 1.5 inch square neoprene or similar blocks, 1/2 inch high. Using spot of sealant underneath to fix to the sill flashing, place on sill. Using the measured width of the sill, place none block about 20% in from left, and the other 20% in from the right.

Using a level, confirm the level heights of the blocks.

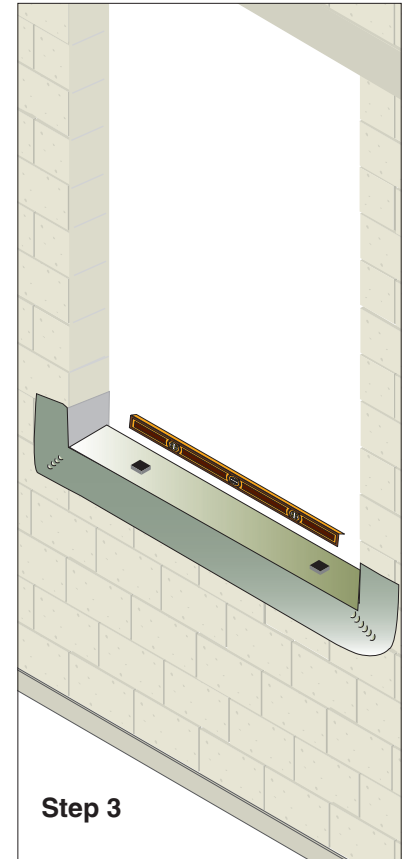
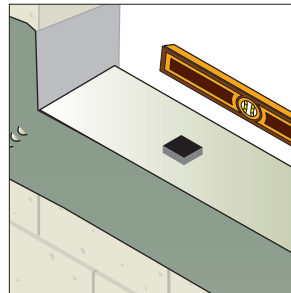

Step 3

Step 2:

Roll out Adhesive-backed Flashing and apply to sill and up minimum of 4 inches on each side.

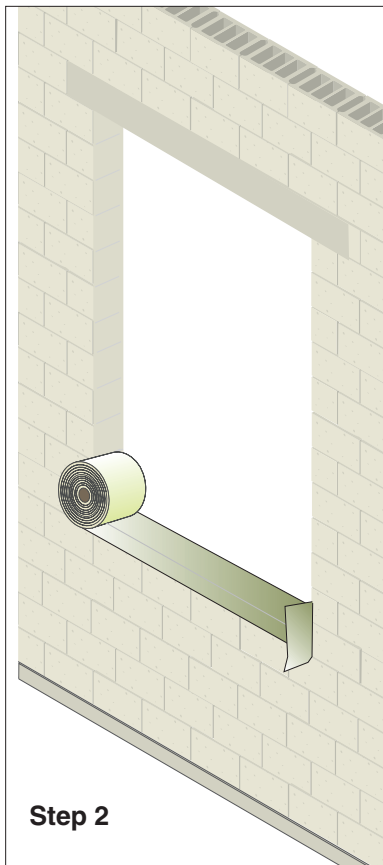
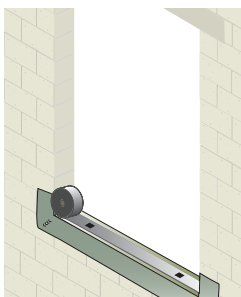

Step 2

Step 4:

Unroll a length of Acrylic impregnated slow expansion foam tape to the width of the sill. Peel off the backing exposing the sticky surface.

Cut out squares to go over the neoprene blocks.

Adhere the Acrylic impregnated slow expansion foam tape to the in-place flashing

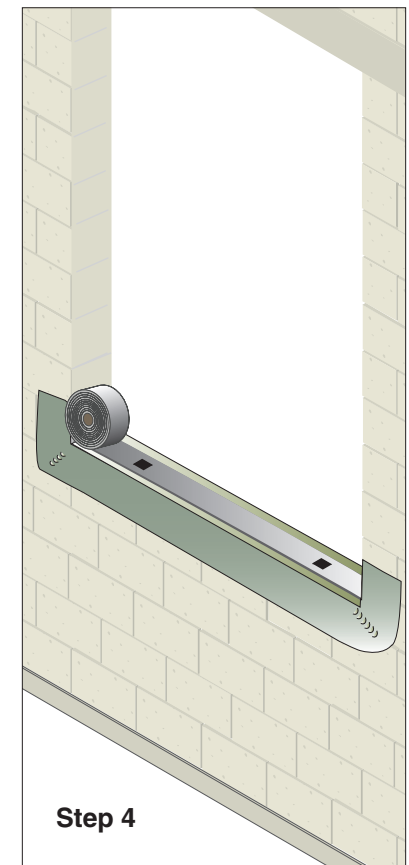

Step 4

Step 5:

Stick lengths of Acrylic impregnated slow expansion foam tape to the two jambs and across the head of the window.

Extend the Acrylic impregnated slow expansion foam tape on the head about 1 inch longer to accommodate shrinkage.

Trim the overlap to prepare for inserting the window.

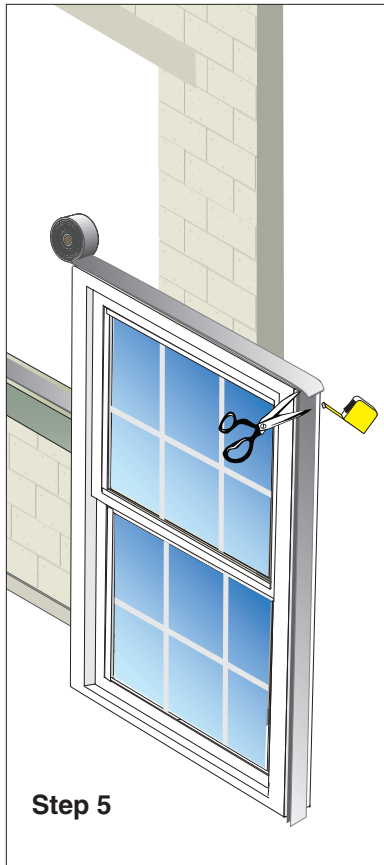

Step 6:

Insert the window into the opening taking care to be sure the Acrylic impregnated slow expansion foam tape is not disrupted.

Use a flat blade putty knife to adjust foam tape to avoid any disruption.

Using a screwdriver, lift up the overlapped foam tape on the header to allow proper seating of the joint during expansion.

Add a bead of caulk to assure water tight.

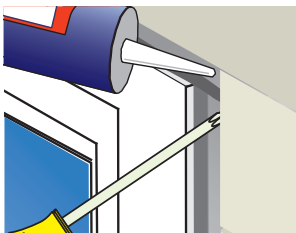

Step 7:

Using proper ShimCon or equal anchors, set jamb anchors and header anchors.

Adjust anchors to shim to plumb and level. Anchor the opposite jamb and re-check plumb and square. Adjust as necessary.

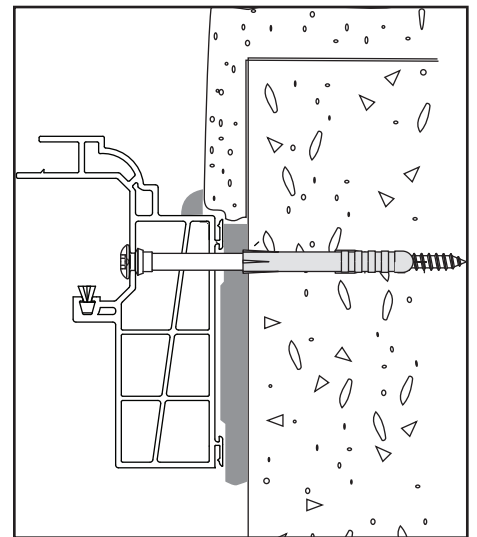

Step 8:

Using exterior snap trim or other finish trim, cover the exposed Acrylic impregnated slow expansion foam tape on four sides.

Caulk joint between trim and window as necessary.

There is no need to caulk/seal the joint between the slow expansion foam tape and the block opening as the stucco finish will provide the proper joint finish.

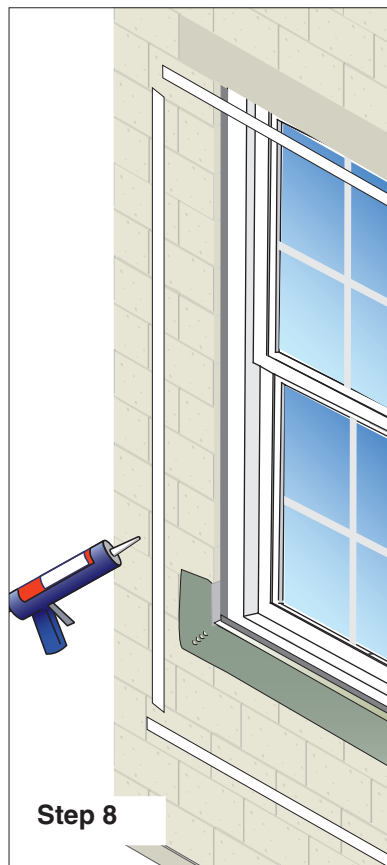

Application Details Wood Frame

Wood Frame Install

Frame the opening as usual leaving 1/2inch or less on each side, and at top and bottom.

Place Hanno along sill and cut out squares to insert cork pads 1-8" to 1/4" less that the opening gap to allow for expansion.

Step 2W

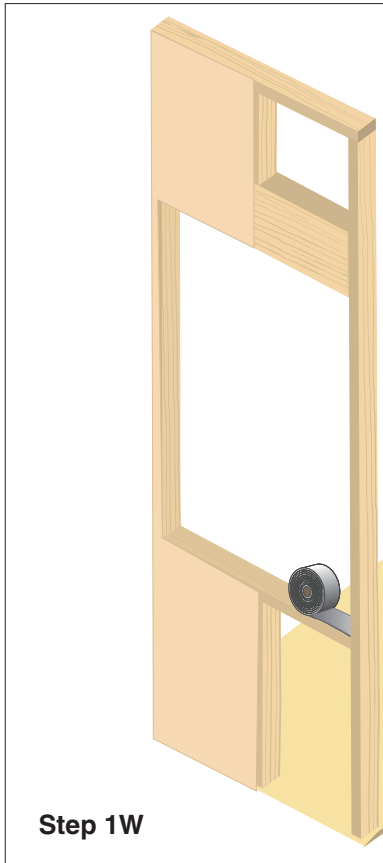
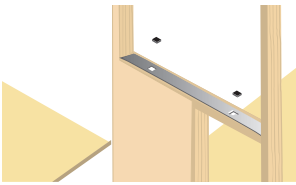

Step 1W

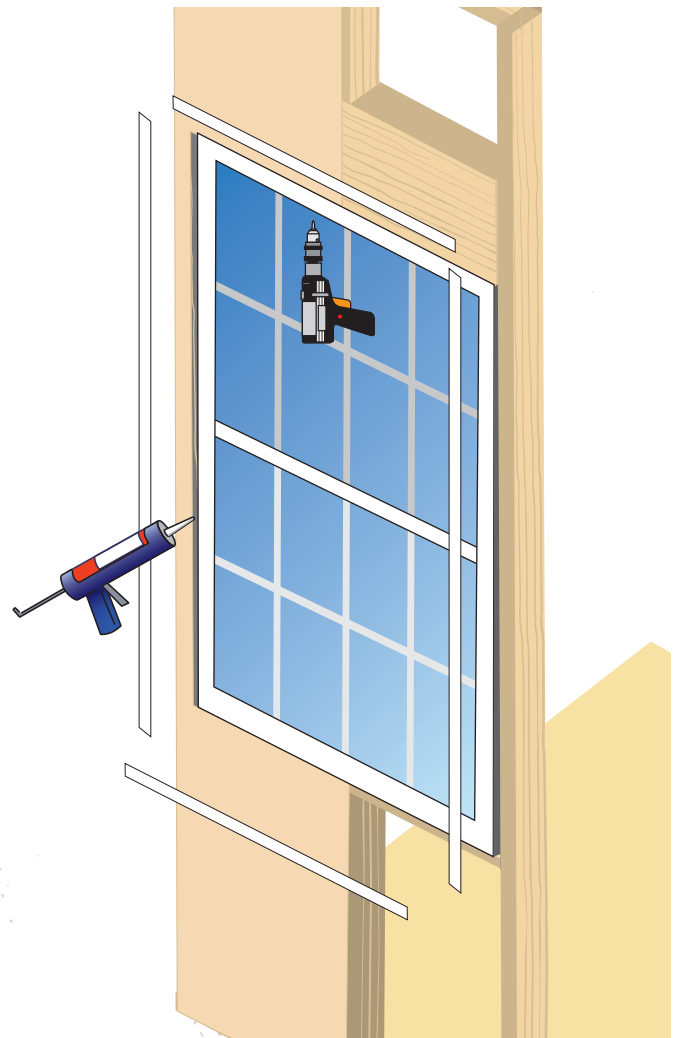

Having wrapped the window as shown in the previous masonry instructions, rest the window bottom on the cork pads and tilt the window into the opening.

Use tape knife to make sure the window moves into the opening without disturbing the Hannobad.

Once in the opening, fasten with Self-Shimming screws until the window is plumb, square and true.

Seal exterior and interior with proper sealants and trim as necessary.

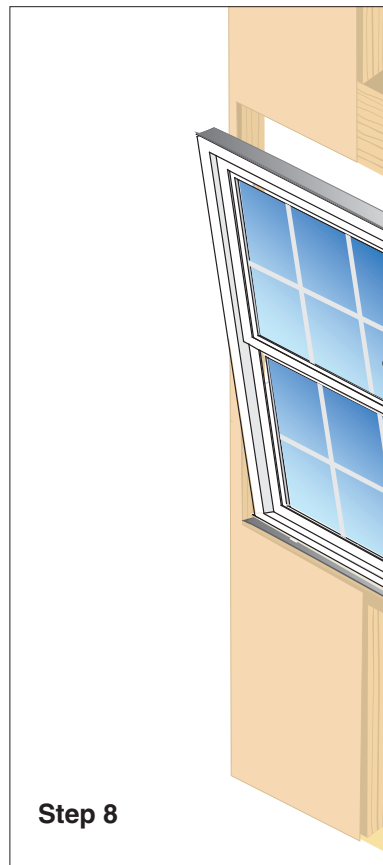

Step 8

